

TOP VIEW

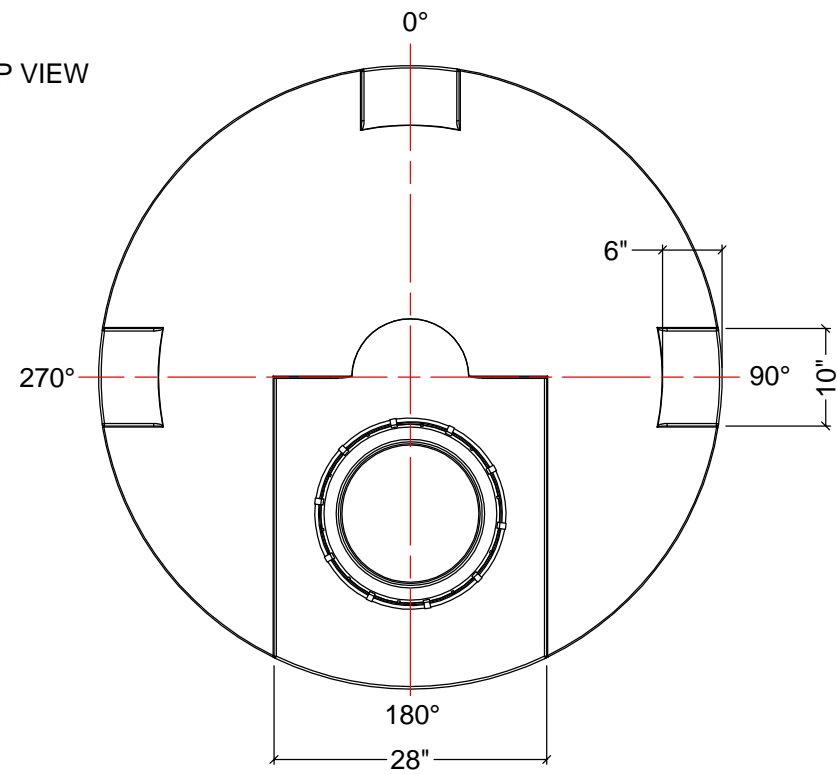

NOTES:

1. TANK IS MANUFACTURED TO ASTM-D-1998 STANDARD.
2. ALL DIMENSIONS ARE APPROXIMATE.

MATERIALS LIST		
ITEMS	DESCRIPTION	NOTES
A	VFA805 VERTICAL TANK	
B	16" LID WITH LOCKING STRAP	

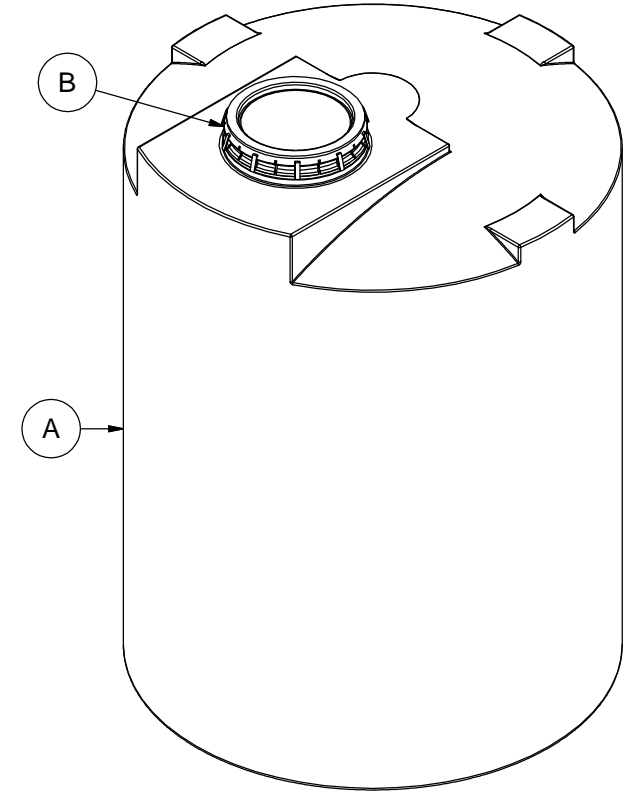
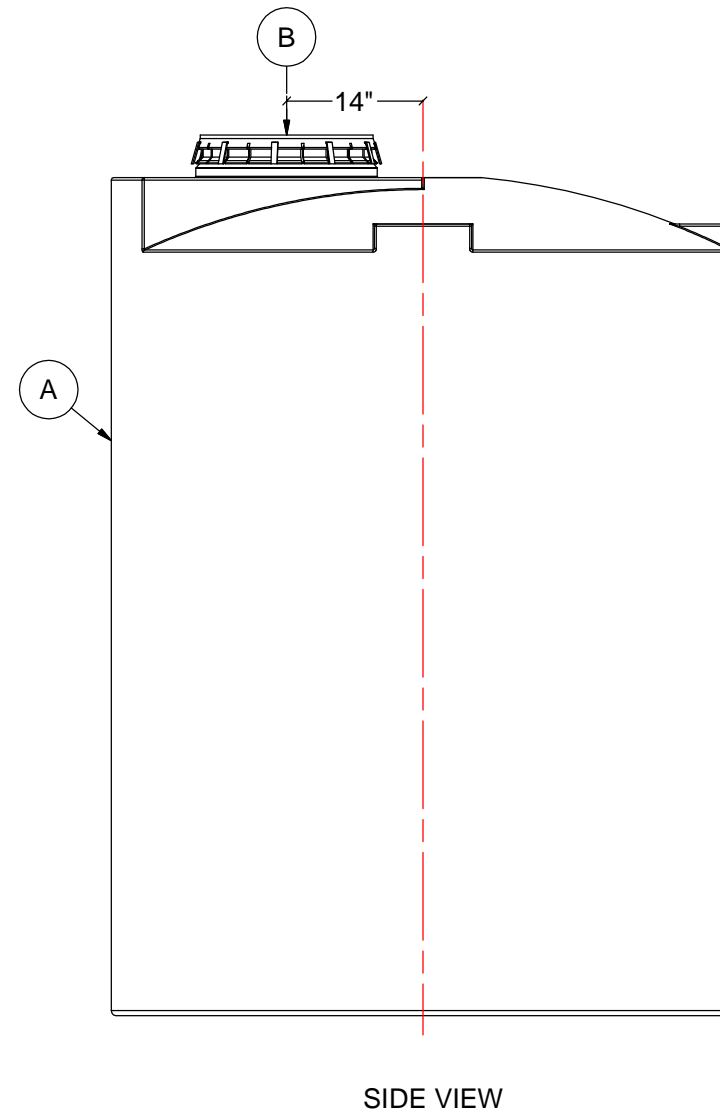
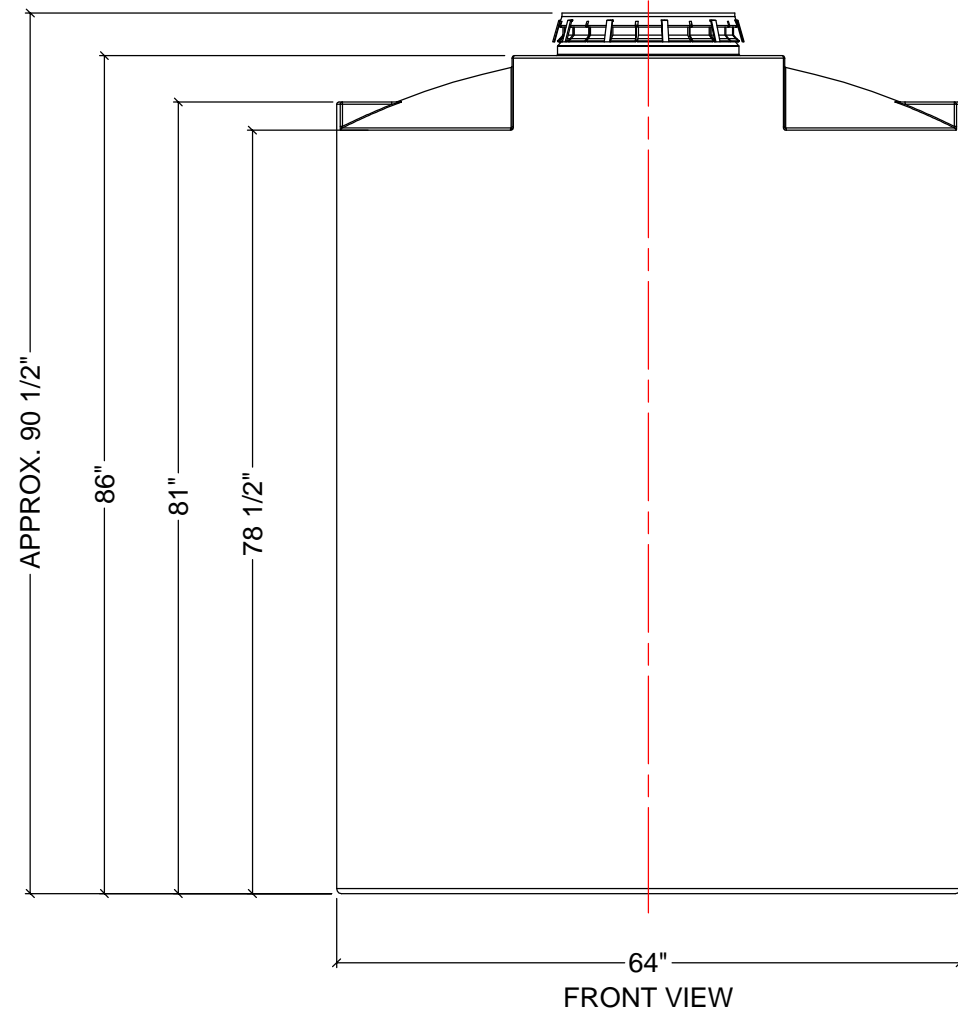

**AGRICO PLASTIQUES**  
 450-471-2772  
[WWW.AGRICOPLASTIQUES.COM](http://WWW.AGRICOPLASTIQUES.COM)  
 RÉSERVOIR VFA805  
 CAPACITÉ DE:  
 800 GALLONS IMPÉRIAUX  
 960 GALLONS US  
 3600 LITRES