

NOTES:

1. TANK IS MANUFACTURED TO ASTM-D-1998 STANDARD.
2. ALL DIMENSIONS ARE APPROXIMATE.

MATERIALS LIST		
ITEMS	DESCRIPTION	NOTES
A	VFA1010 VERTICAL TANK	
B	16" LID WITH LOCKING STRAP	

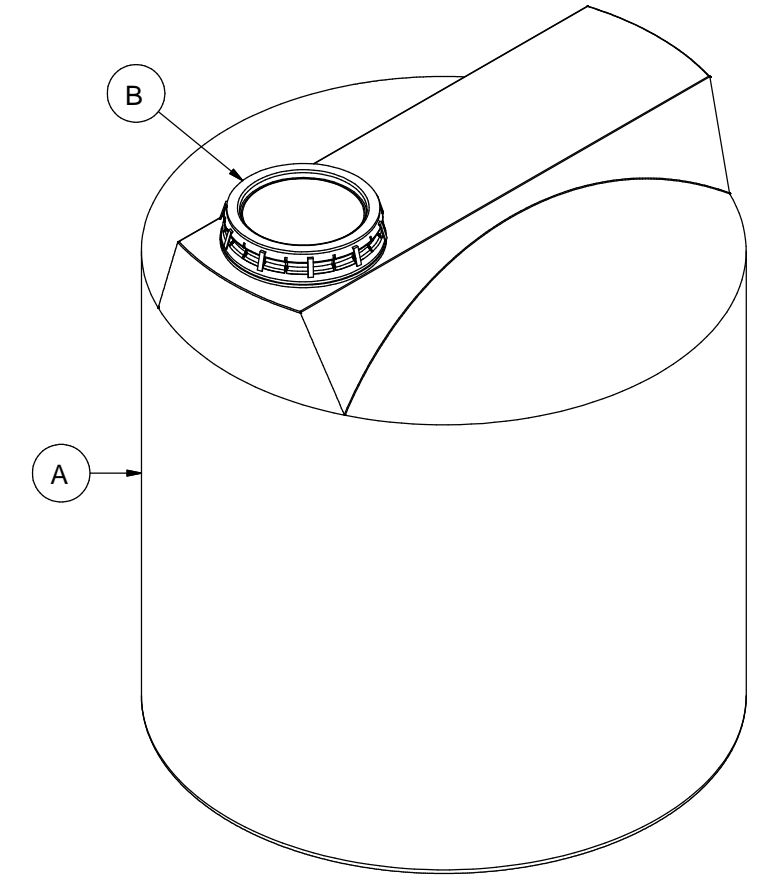
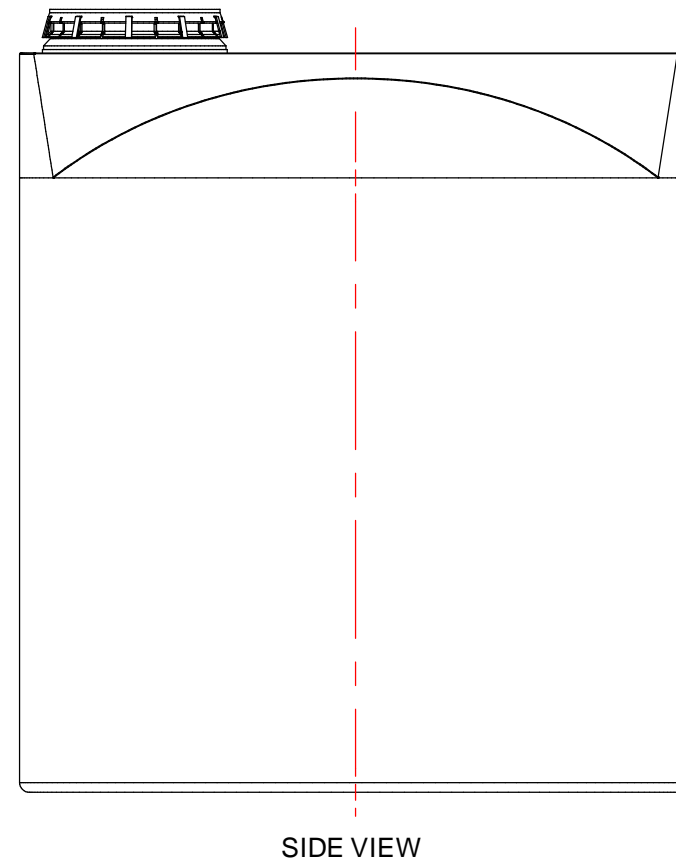
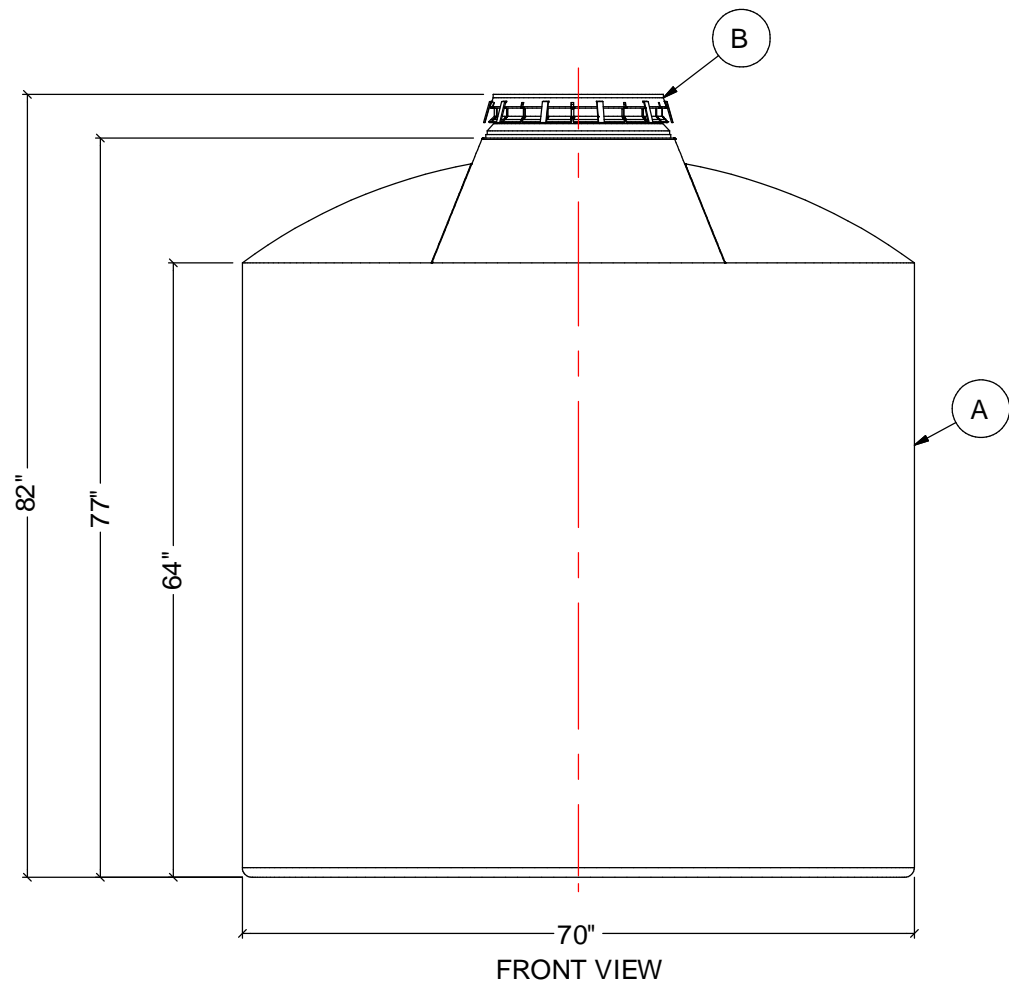

**AGRICO PLASTIQUES**  
450-471-2772  
[WWW.AGRICOPLASTIQUES.COM](http://WWW.AGRICOPLASTIQUES.COM)

RÉSERVOIR VFA1010  
CAPACITÉ DE:  
1000 GALLONS IMPÉRIAUX  
1200 GALLONS US  
4500 LITRES