

RÉSERVOIR VERTICAL OUVERT 150 GALLONS US

NOTES:

- 1. TANK IS MANUFACTURED TO ASTM-D-1998 STANDARD.
- 2. ALL DIMENSIONS ARE APPROXIMATE.

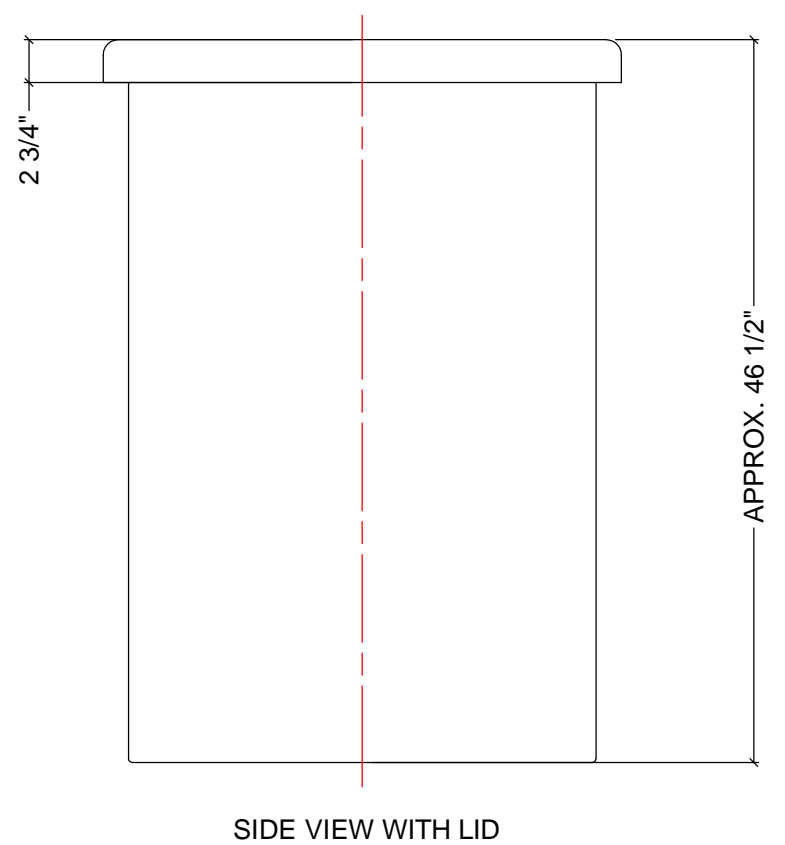
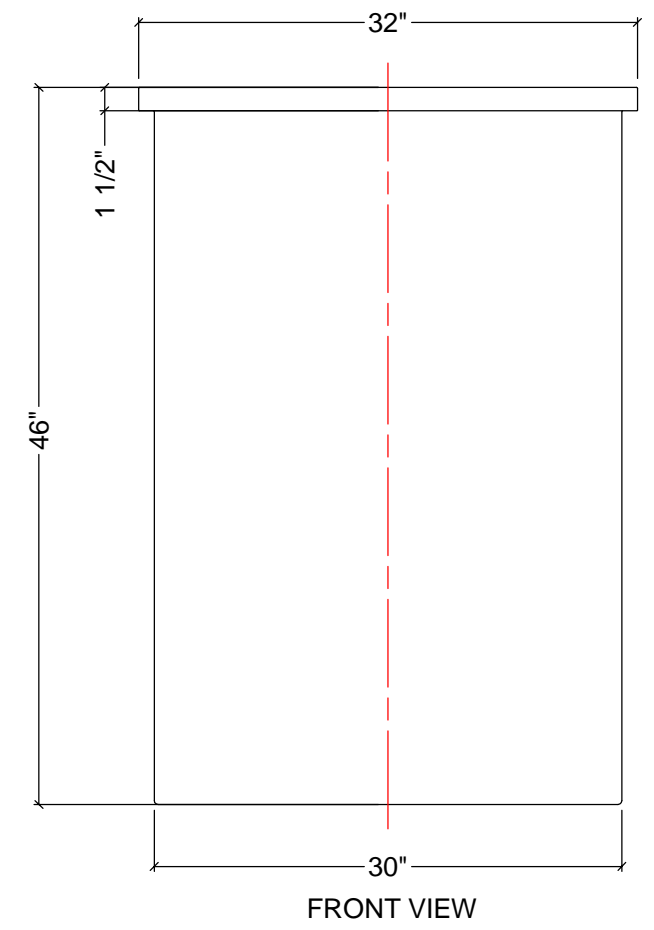
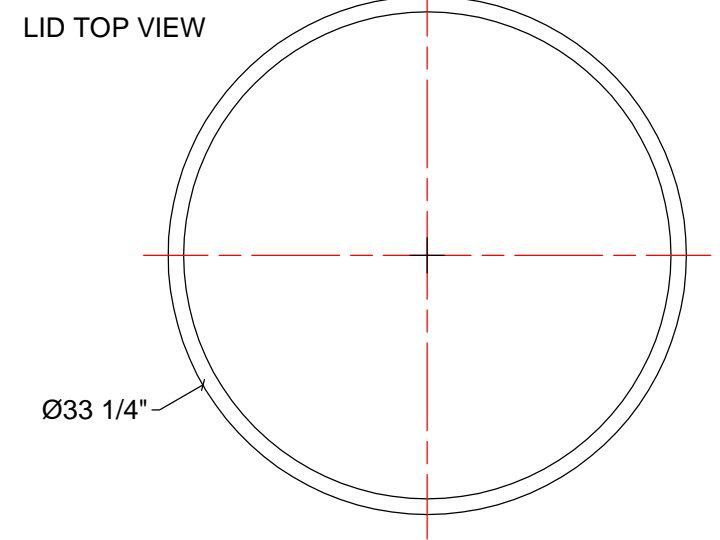
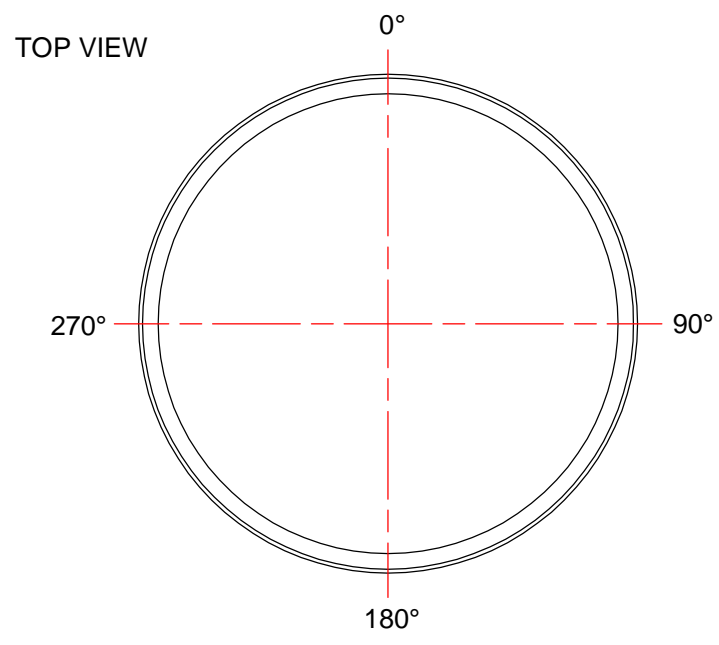

MATERIALS LIST		
ITEMS	DESCRIPTION	NOTES
A	OT12515 / OT12519 OPEN TOP TANK	
B	LID FOR OT125	

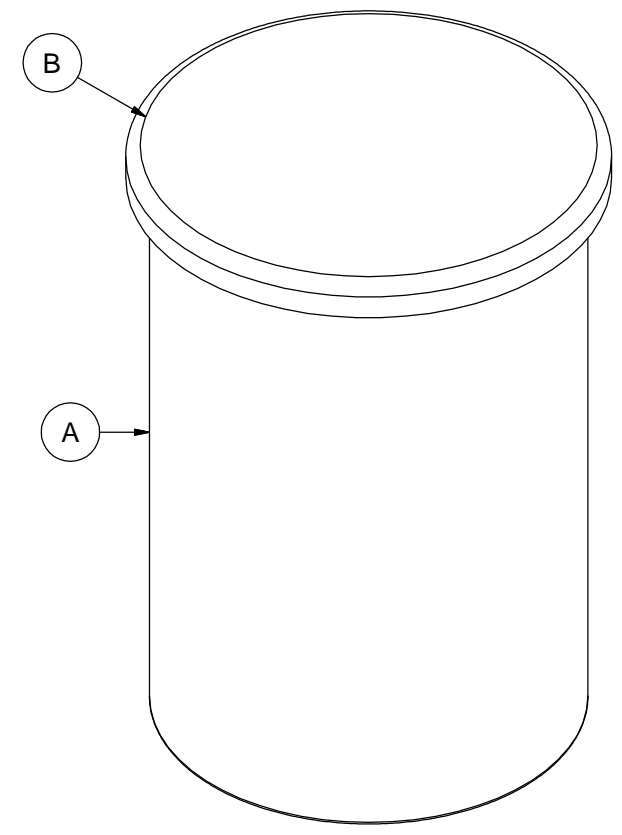

AGRICO PLASTIQUES
 450-471-2772
WWW.AGRICOPLASTIQUES.COM
 RÉSERVOIR OT12515 / OT12519
 CAPACITÉ DE:
 125 GALLONS IMPÉRIAUX
 150 GALLONS US
 568 LITRES