

RÉSERVOIR VERTICAL OUVERT 480 GALLONS US

NOTES:
 1. TANK IS MANUFACTURED TO ASTM-D-1998 STANDARD.
 2. ALL DIMENSIONS ARE APPROXIMATE.

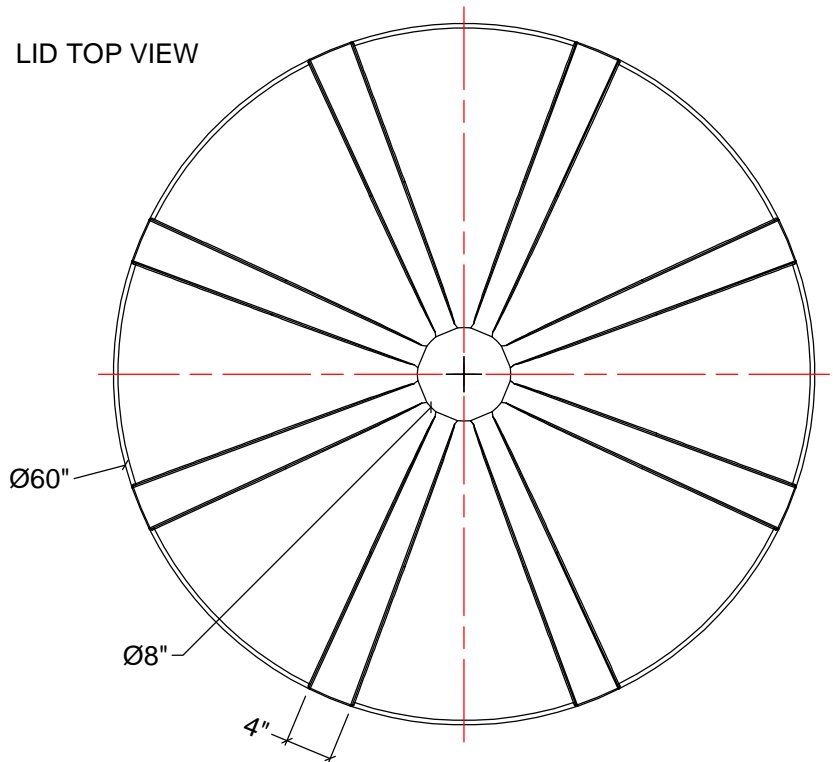

MATERIALS LIST		
ITEMS	DESCRIPTION	NOTES
A	OT40015 / OT40019 OPEN TOP TANK	
B	LID FOR OT400	

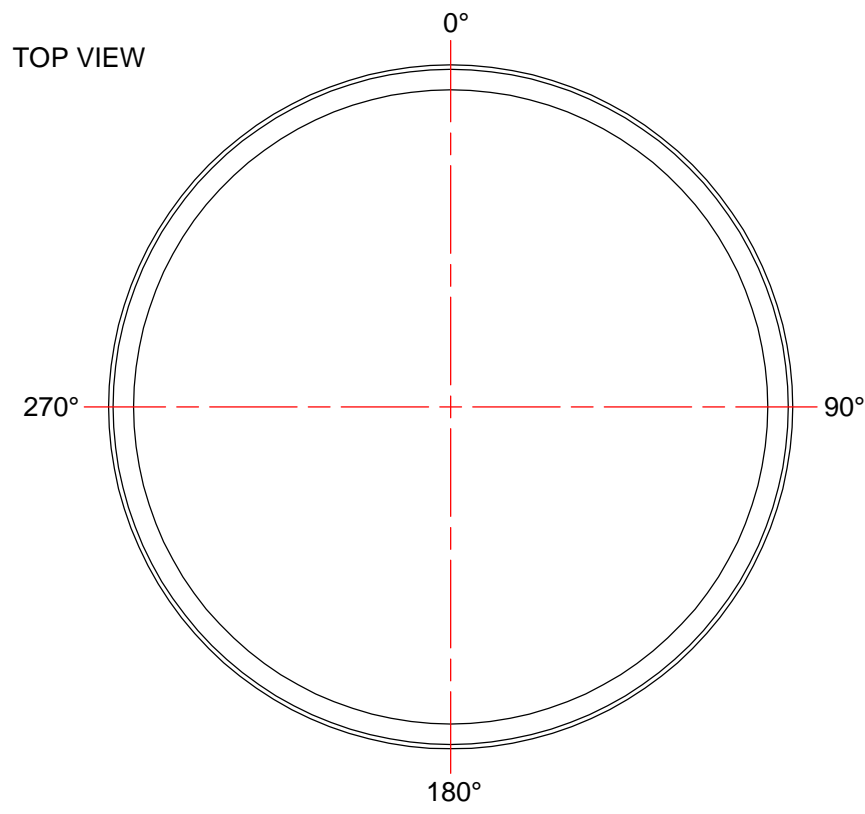
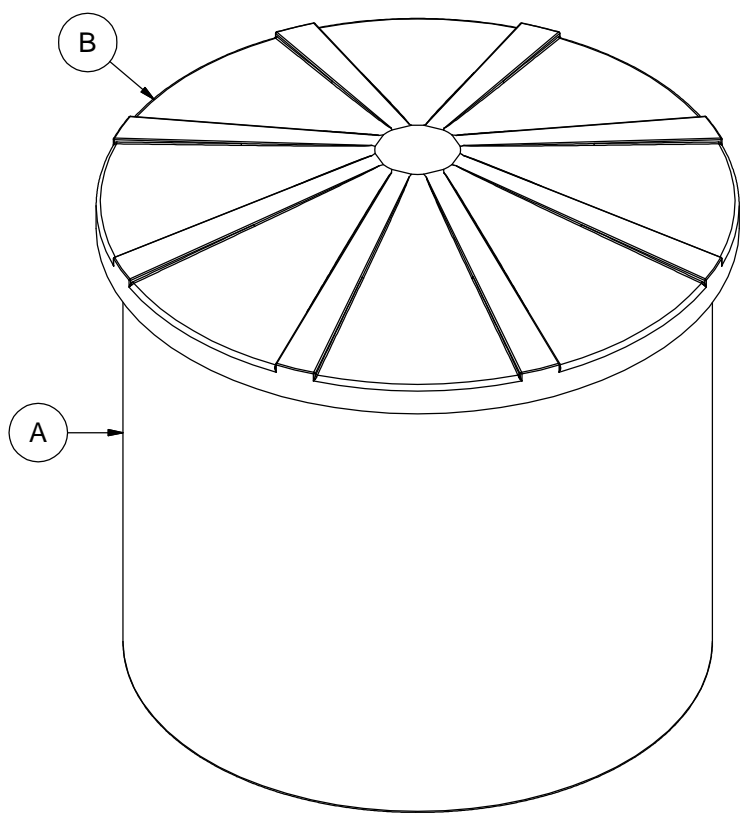
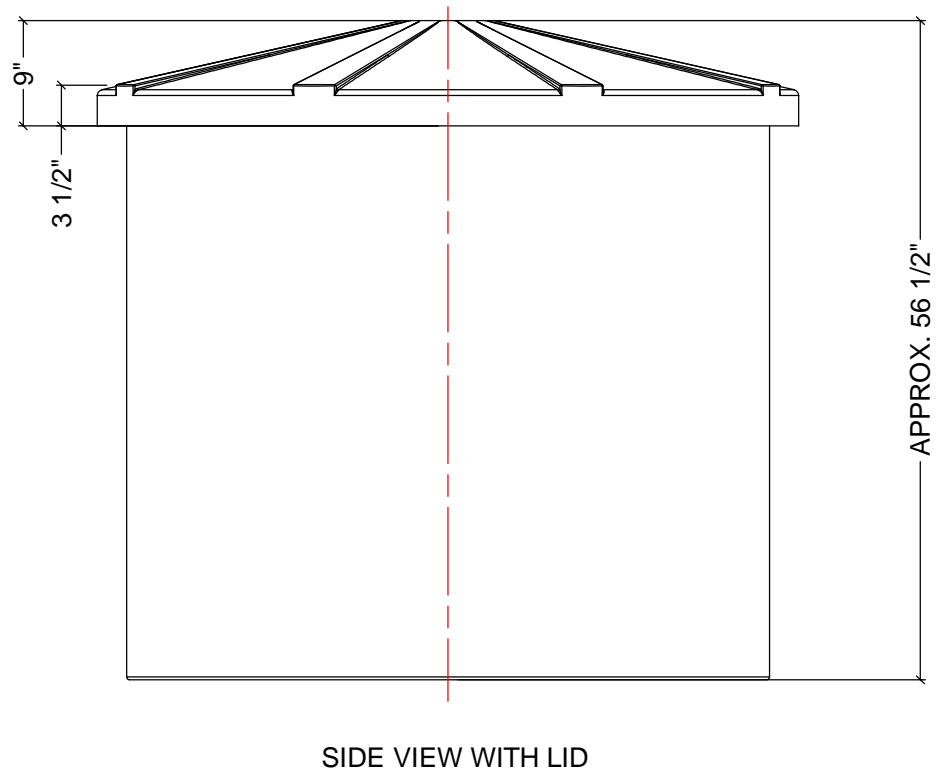
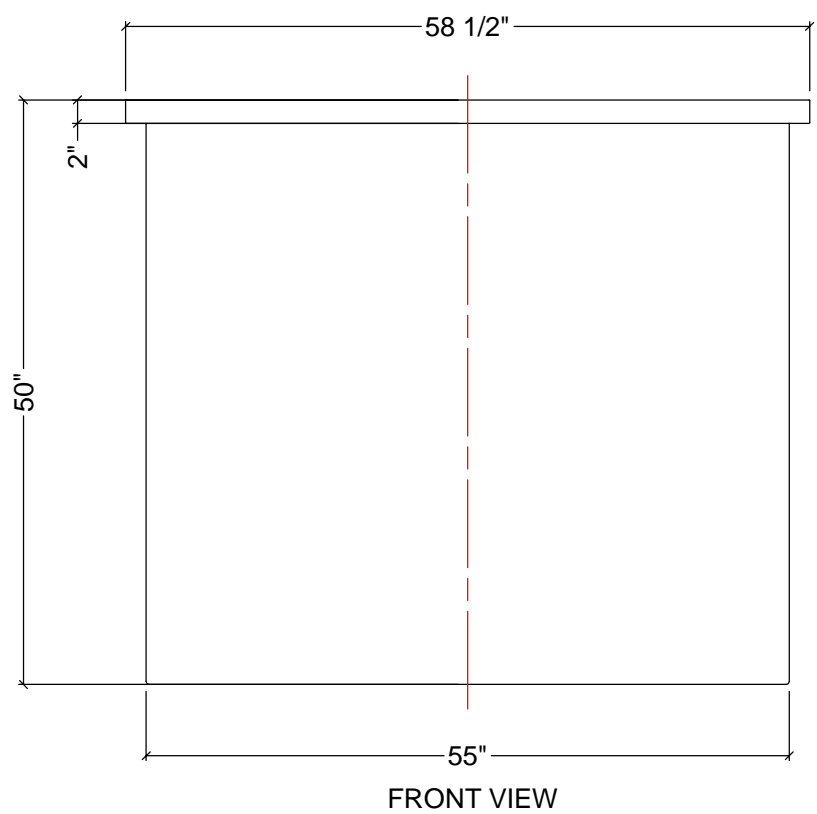

AGRICO PLASTIQUES
 450-471-2772
WWW.AGRICOPLASTIQUES.COM
 RÉSERVOIR OT40015 / OT40019
 CAPACITÉ DE:
 400 GALLONS IMPÉRIAUX
 480 GALLONS US
 1818 LITRES