

MATERIALS LIST

ITEMS	DESCRIPTION	NOTES
A	IRD-185 SECONDARY CONTAINMENT BASIN	

NOTES:

1. TANK IS MANUFACTURED TO ASTM-D-1998 STANDARD.
2. TANK CAPACITY: 185 I.G. (800 L).
3. ALL DIMENSIONS ARE APPROXIMATE.

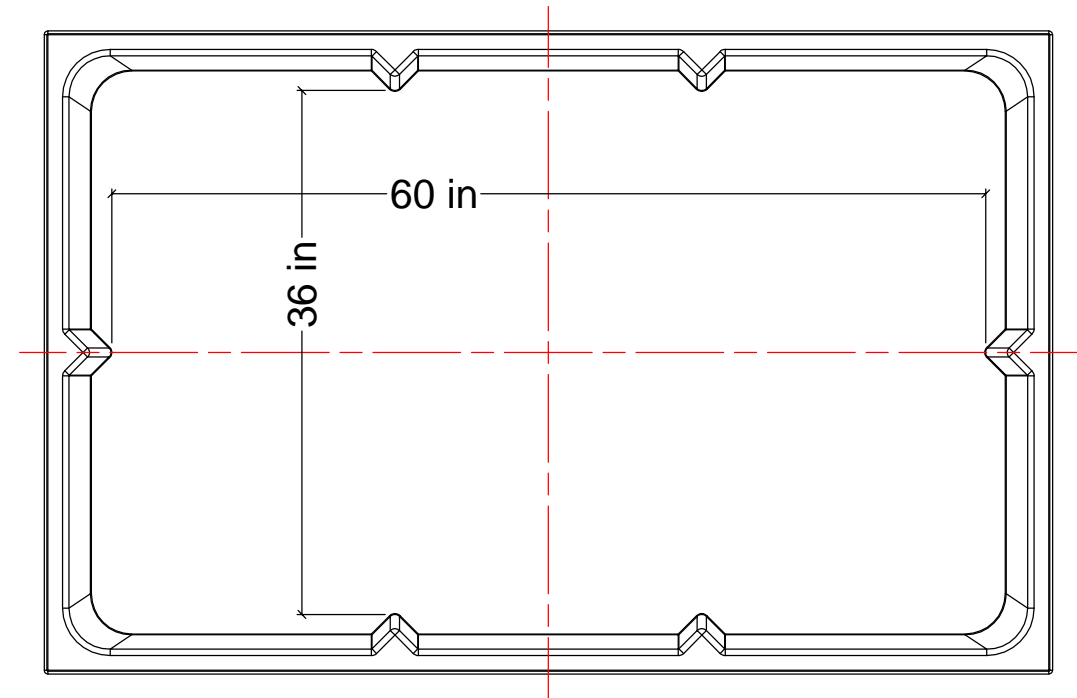

TOP VIEW

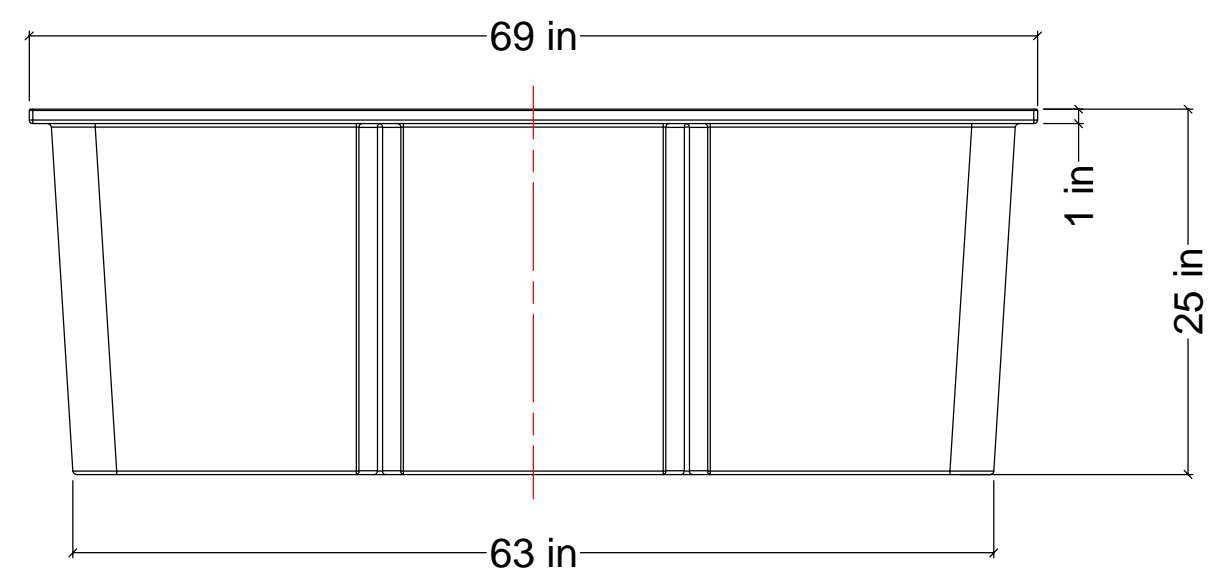
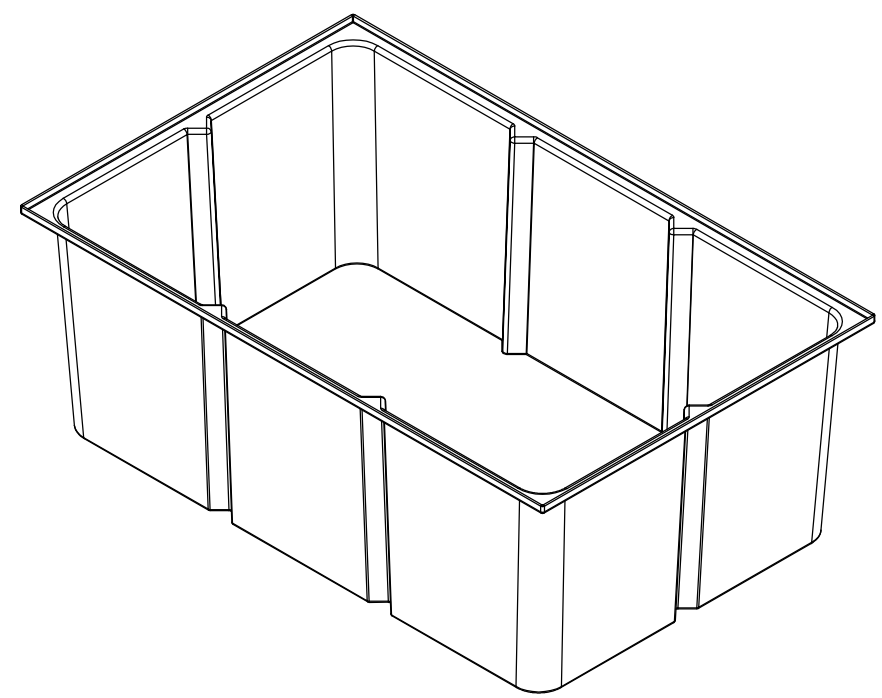

FRONT VIEW

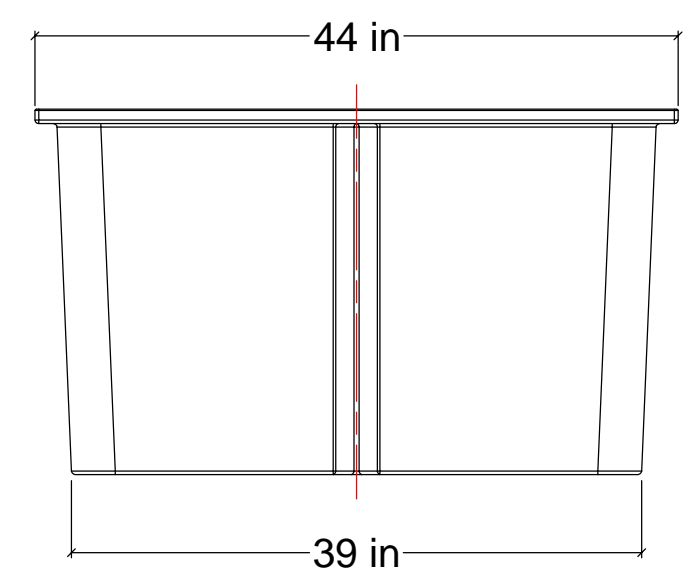

SIDE VIEW

AGRICO PLASTIQUES
 450-471-2772
WWW.AGRICOPLASTIQUES.COM
 RÉSERVOIR IRD185
 CAPACITÉ DE:
 185 GALLONS IMPÉRIAUX
 222 GALLONS US
 841 LITRES