

MATERIALS LIST

ITEMS	DESCRIPTION	NOTES
A	IRD-310 SECONDARY CONTAINMENT BASIN	

NOTES:

1. TANK IS MANUFACTURED TO ASTM-D-1998 STANDARD.
2. TANK CAPACITY: 310 I.G. (1400 L).
3. ALL DIMENSIONS ARE APPROXIMATE.

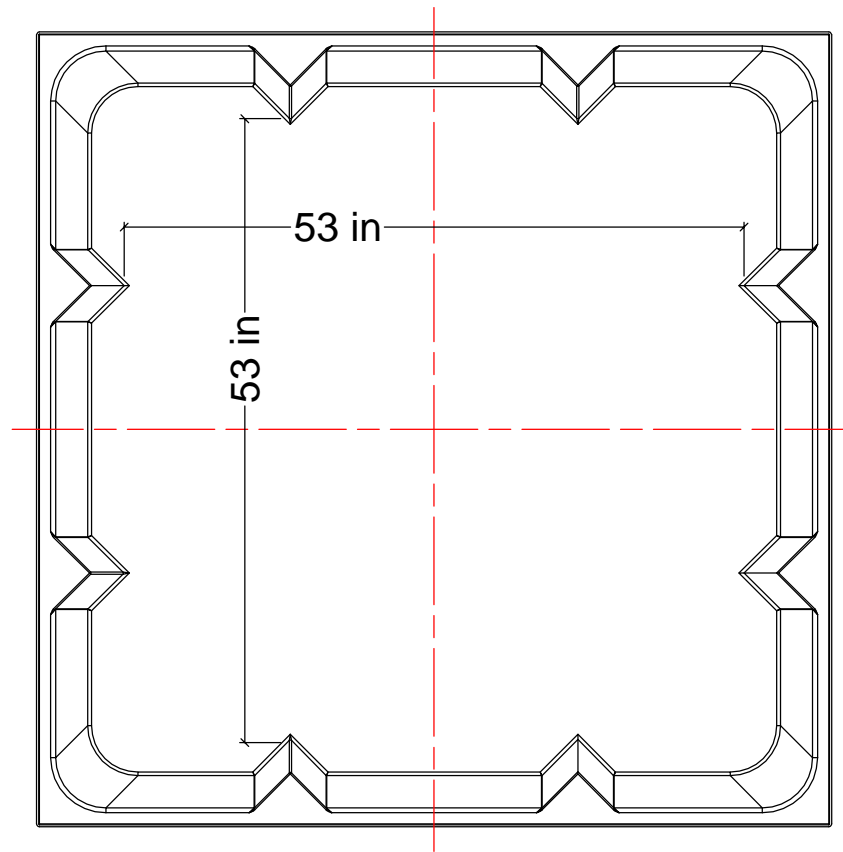

TOP VIEW

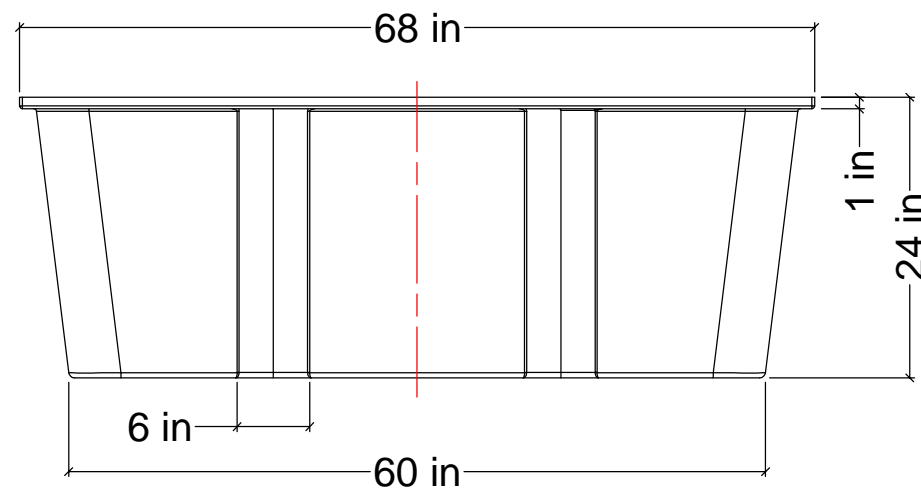
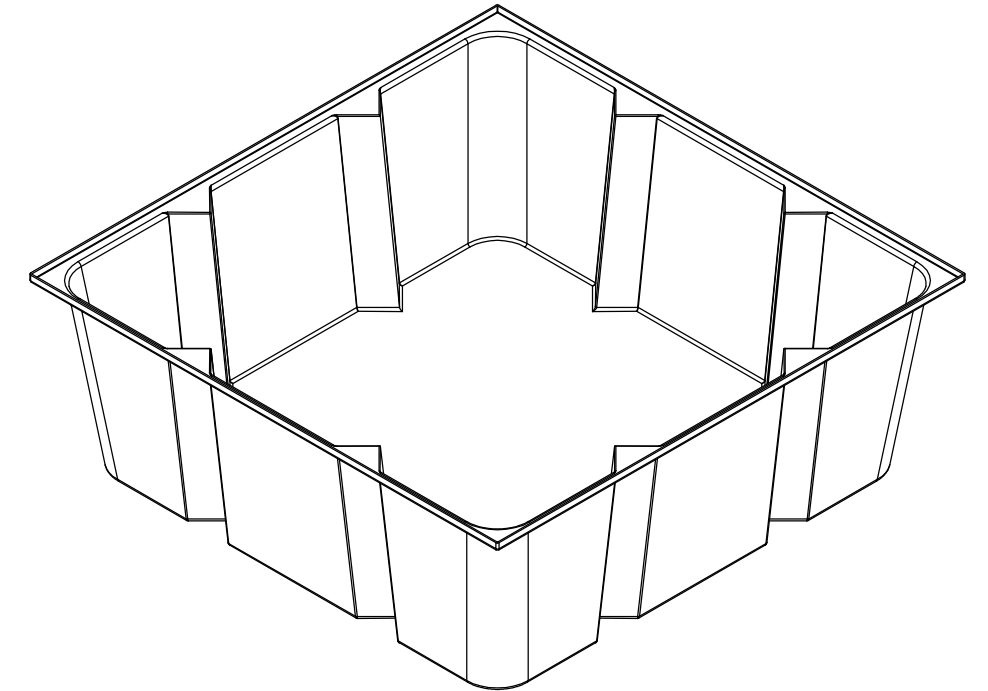

FRONT VIEW

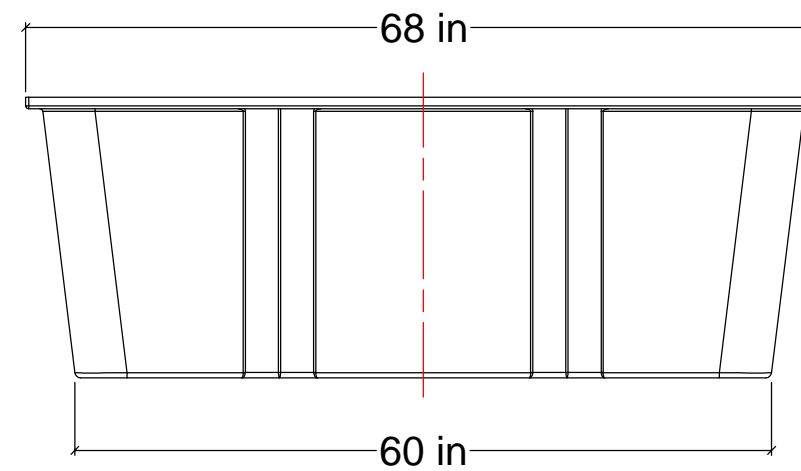

SIDE VIEW

AGRICO PLASTIQUES
450-471-2772

WWW.AGRICOPLASTIQUES.COM

RÉSERVOIR IRD310

CAPACITÉ DE:
310 GALLONS IMPÉRIAUX
372 GALLONS US
1409 LITRES