

MATERIALS LIST

ITEMS	DESCRIPTION	NOTES
A	IRD-410 SECONDARY CONTAINMENT BASIN	

NOTES:

1. TANK IS MANUFACTURED TO ASTM-D-1998 STANDARD.
2. TANK CAPACITY: 410 I.G. (1800 L).
3. ALL DIMENSIONS ARE APPROXIMATE.

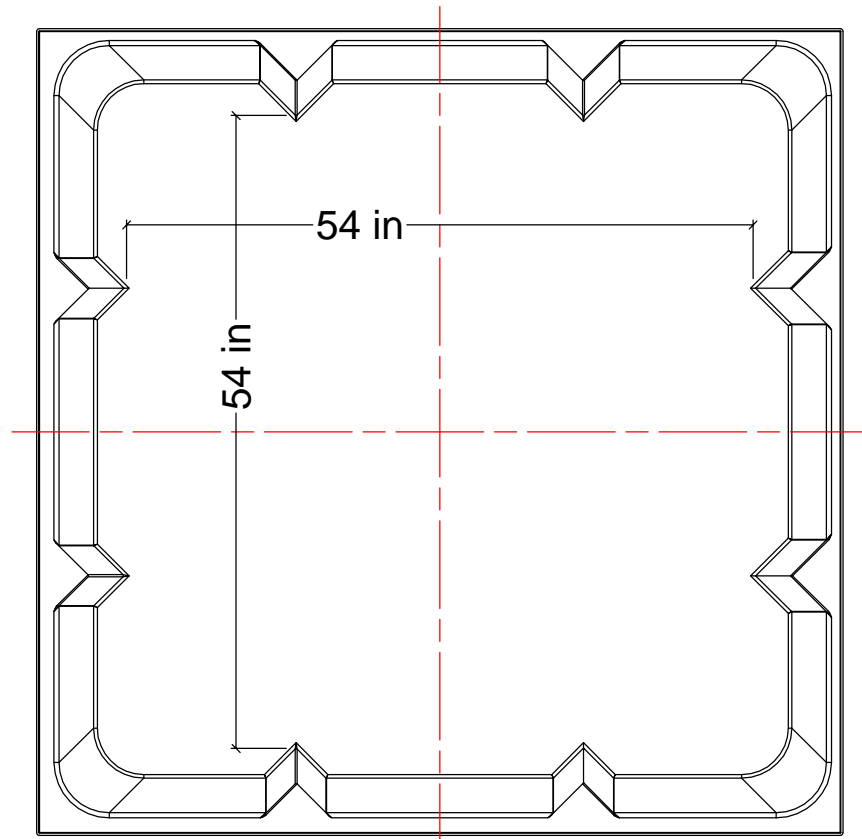

TOP VIEW

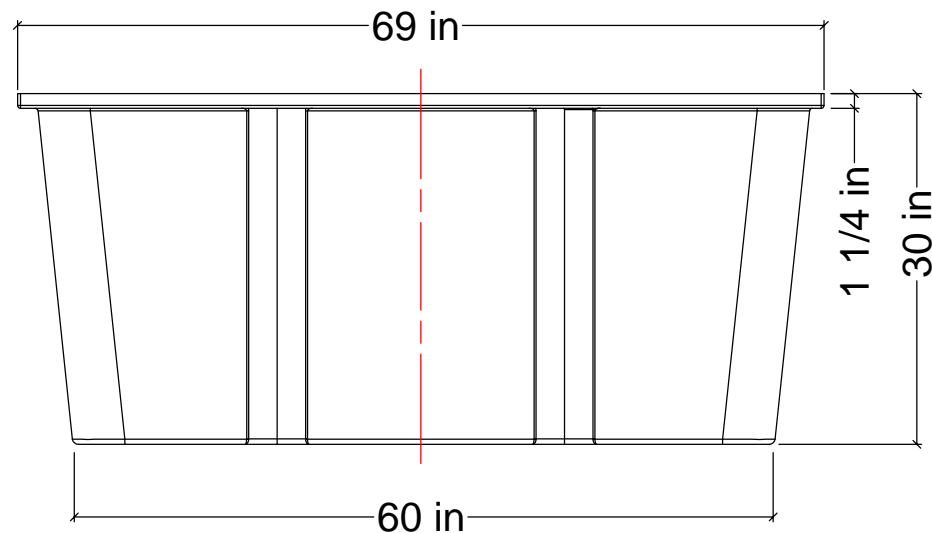
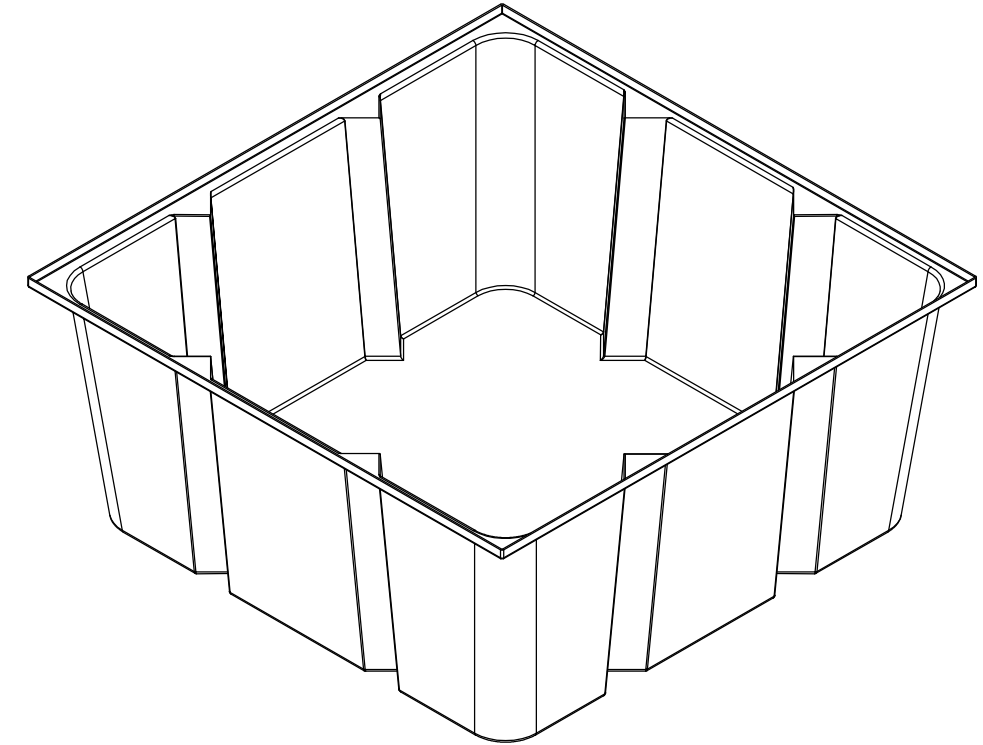

FRONT VIEW

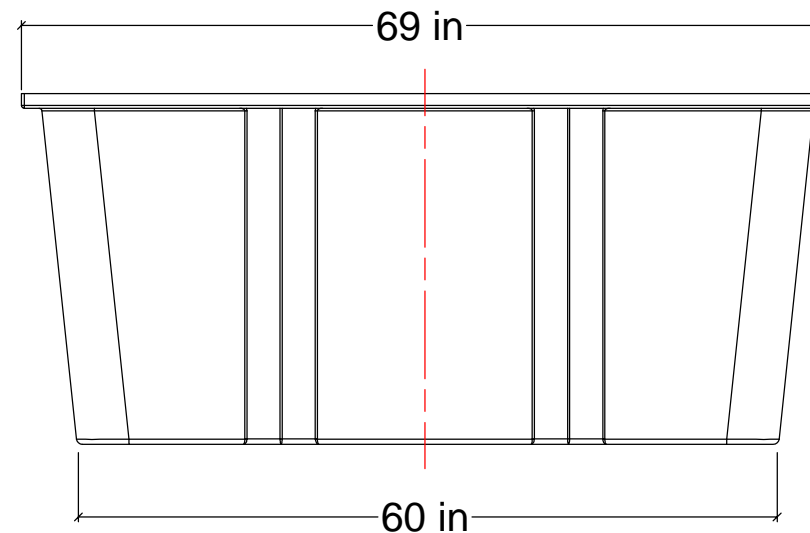

SIDE VIEW

AGRICO PLASTIQUES
450-471-2772

WWW.AGRICOPLASTIQUES.COM

RÉSERVOIR IRD410

CAPACITÉ DE:
410 GALLONS IMPÉRIAUX
492 GALLONS US
1864 LITRES