

REVISIONS				
ZONE	REV	DESCRIPTION	DATE	APPROVED

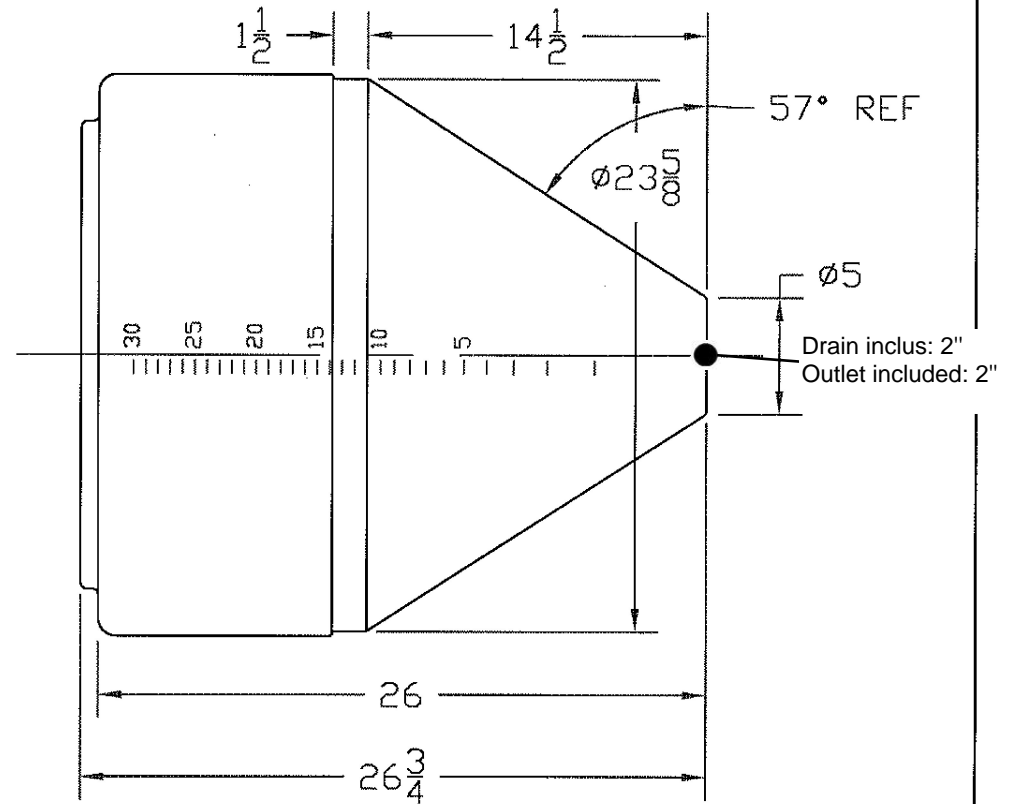

CBN42065	AGRICO PLASTIQUES 450-471-2772 WWW.AGRICOPLASTIQUES.COM			
	30 GALLON INDUCTOR TANK x 24 DIA			
JTP 02APR04	SIZE A	FSCM NO.	DWG NO.	REV
SCALE 1/8		SHEET		